

Electronic Skincare Cassette Dispenser Floor Stand Instruction Sheet

Taking a Stand on Clean Hands

The new Electronic Cassette Dispenser Floor Stand now makes it even easier to keep hands clean and sanitised in your facility. This stand, combined with an Electronic Cassette Dispenser, provides flexibility in placing hand sanitising stations in multiple locations.

Product Code 11430 Description

Dispenser Floor Stand for Electronic Cassette Skin Care Dispensers, available in black metal and plastic construction. Includes base, 3-piece pole, mounting plate, and hardware. 3-piece pole enables short, medium and tall dispenser presentation (see instructions below).

Hardware and basic tools are included and assembly is required (approximately 5 minute assembly time). The Electronic Cassette Skin Care Dispenser can be fastened to the mounting plate upon alignment of pre-drilled holes and use of screws included in the stand's hardware pack.

Graphical Directions:

Pole included will be in 3 unassembled segments. You may assemble as follows:

One Pole Stand

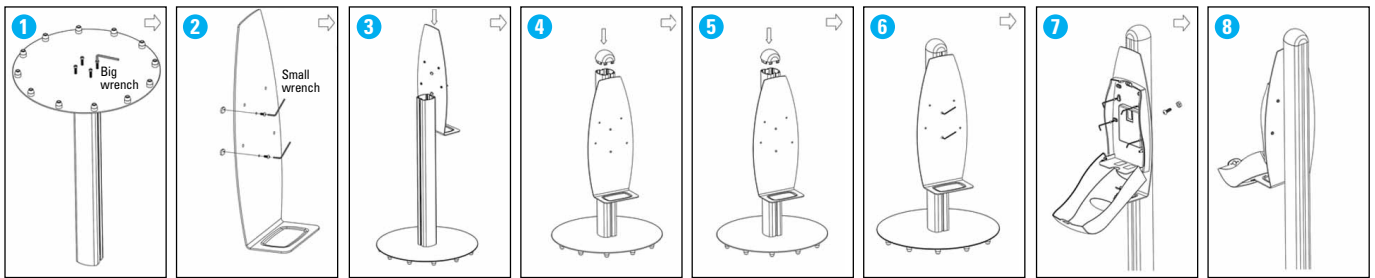

Two Pole Stand

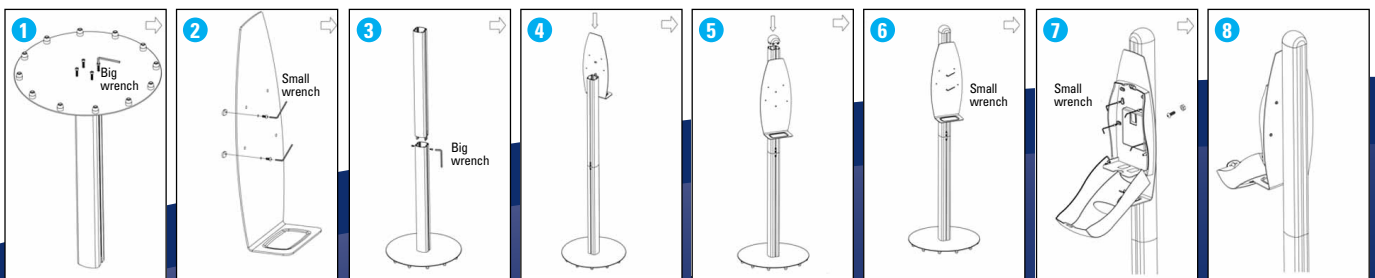

Three Pole Stand

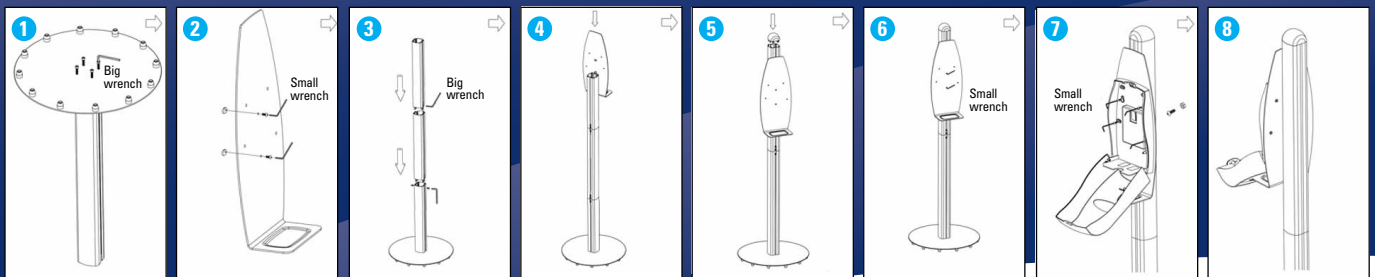

Electronic Skincare Cassette Dispenser Floor Stand

An Electronic Cassette Skin Care Dispenser is not included with the Floor Stand.

There is an approximate 5 minute assembly time for the Floor Stand.

Floor Stand includes:

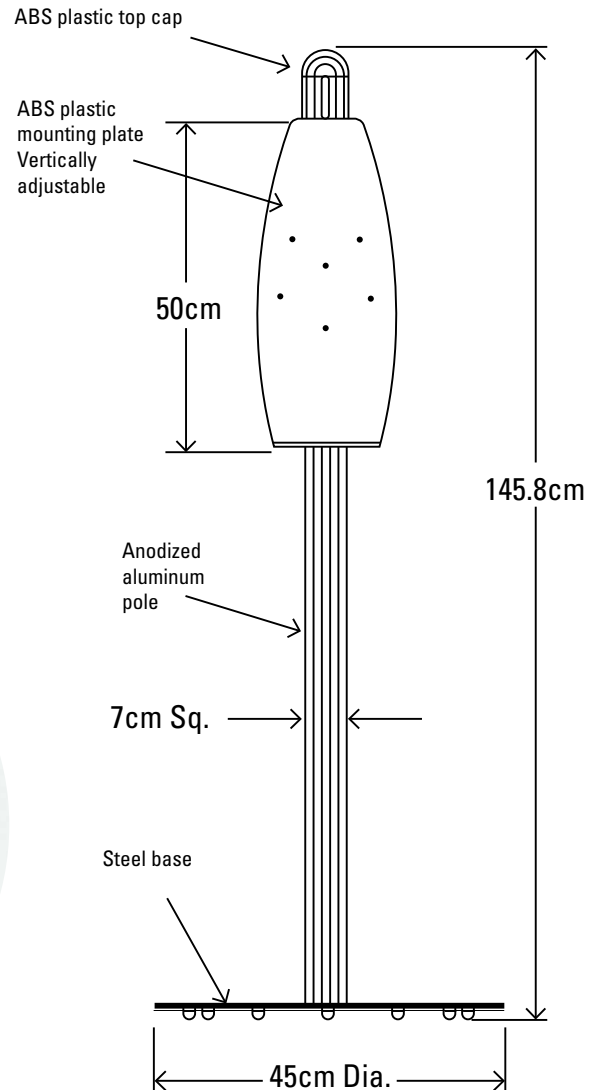

- Base, 3-piece pole, mounting plate
- Dispenser mounting hardware
- Pole assembly hardware
- Basic tools
- Instruction sheet



Electronic Cassette Dispenser Floor Stand

Description	Code No.	Finish	Dimensions (W x H x D)	Case Count
KLEENEX® Electronic Cassette Dispenser Floor Stand	11430	Black	45cm x 145.8cm x 45cm	1 x 

Electronic Dispenser

Description	Code No.	Finish	Dimensions (W x H x D)	Case Count
KIMBERLY-CLARK PROFESSIONAL* Electronic Cassette Skin Care Dispenser	11329	Brushed Metallic	18.4cm x 29.15cm x 10.16cm	1 x 
KIMBERLY-CLARK PROFESSIONAL* Electronic Cassette Skin Care Dispenser	92147	White	18.4cm x 29.15cm x 10.16cm	1 x 

Electronic Cassette Skincare System

Description	Code No.	Case Count	Refill size	Fragrance/Colour	Dispenser
KLEENEX® Luxury Foam Moisturising Instant Hand Sanitiser	91950	2 x 	1200ml	Fruity Cucumber/Clear	11329, 92147

SUPPORT & QUALITY GUARANTEED

No Risk Trial

We are confident that the products we recommend will improve your productivity, control costs, and enhance hygiene. If, after a 60 day trial (or an agreed time), you have spent more than your current washroom, wiping or skincare system, we will reimburse the difference with Kimberly-Clark product (up to a maximum value of \$1000).

Guarantee of satisfaction

Our 'no-quibble' guarantee, covering all Kimberly-Clark Professional Products, assures you of trouble-free performance by our recommended systems. The quality and consistency of our products allows us to offer a money-back or replacement of stock guarantee.

Guaranteed support

We are proud of our after sales service. Our national network of distributors and sales representatives are on hand when you need them, the answer to any query you may have is just a phone call away.

Australia 1800 647 994 New Zealand 0800 447 814 Email kcp.au@kcc.com www.kcprofessional.com.au